

Artist Quality, Extraordinary from Top to Bottom

Vitarte
维亚帝

My Villa, My Vitarte

Longtron
龙闯电梯



4007-888-521

Lon Chuang Intelligent Technology (Zhejiang) Co., Ltd

www.vitarte.cn

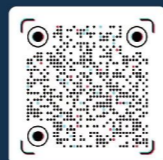

TikTok



YouTube

Scan here for more information!

My Villa, My Vitarte 艺术品质 俯仰之间皆非凡
Vitarte



Longtron
龙闯电梯

COMPANY PROFILE

Lon Chuang Smart Home (Jiaxing) Co., Ltd. is an innovative company specializing in the design, research and development, as well as manufacturing of home lifts worldwide. Headquartered in the Chinese city of Jiaxing, the company has two R&D and manufacturing bases in Suzhou and Jiaxing. We are committed to providing quality products that meet the smart home lifestyle needs of global consumers.

Lon Chuang is dedicated to innovation, creative trends, as well as safe design and manufacturing. We are one of the leading companies that build artistic and comfortable home lifts, as opposed to conventional lifts that are dull. Visual elements are combined with rigidity and flexibility in material selection to create cozy lifts that boost users' quality of life.

龙闯电梯

龙闯电梯

Vitarte
维亚帝

My Villa, My Vitarte

★ Longchuang Elevator's new factory (Phase I) in Jiaxing has a total planned investment of 100 million yuan and a total construction area of 33,179.43 square meters.

VISION 愿景

Uplift the quality of human life.



Home lifts, I choose Vitarte

Artist Quality,
Extraordinary from Top to Bottom



BRAND STORY

Premium quality with meticulous care

As a luxury brand of Lon Chuang, Vitarte is determined and passionate about building a better life. Vitarte homelifts can be used in all multi-story homes, allowing users to travel between floors in comfort and ease.



VITARTE LUXE SERIES

Smart and mechanical dual system: Combining the advantages of traction and screw-driven lifts.

Designed with a thick circular arc frame and complementary structure and lines, Vitarte lifts have won international design awards for its functionality and creativity.



VITARTE CHIC2.0 SERIES

Chinese style of design: Quiet enjoyment

The frame structure with Chinese design aesthetics has a round exterior and square interior, concealing the edges of conventional lifts to prevent accidents and injuries. It balances artistry and functionality, exuding restrained luxury vibes.



Awards



2025 Home Elevator Excellence Leadership Award



Conformité Européenne



German Design Award



Grand Prix du Design Paris Award



IAI Intelligent Manufacturing Award



Kapok Design Award China



Outstanding Product Innovation Award and Outstanding Quality Brand Award at International Quality Festival



Italy International Design Award

Patents



Patents



Chinese design aesthetics

Committed to the brand concept of “artistic life”, elegant design, smart control technology and excellent quality, Vitarte’s lifts combine functionality and artistry to meet the design preferences and usage habits of families. Italian design elements are also incorporated with Chinese aesthetics to showcase sophistication and the beauty of oriental design.



STARRY SKY

ROMANTIC STARRY SKY LIFT CEILING

The ceiling of the C-shaped platform can be customized with motifs of a starry sky and constellations of the zodiac, elevating residences with a dreamy lift riding experience.

Vitor-te
维亚帝

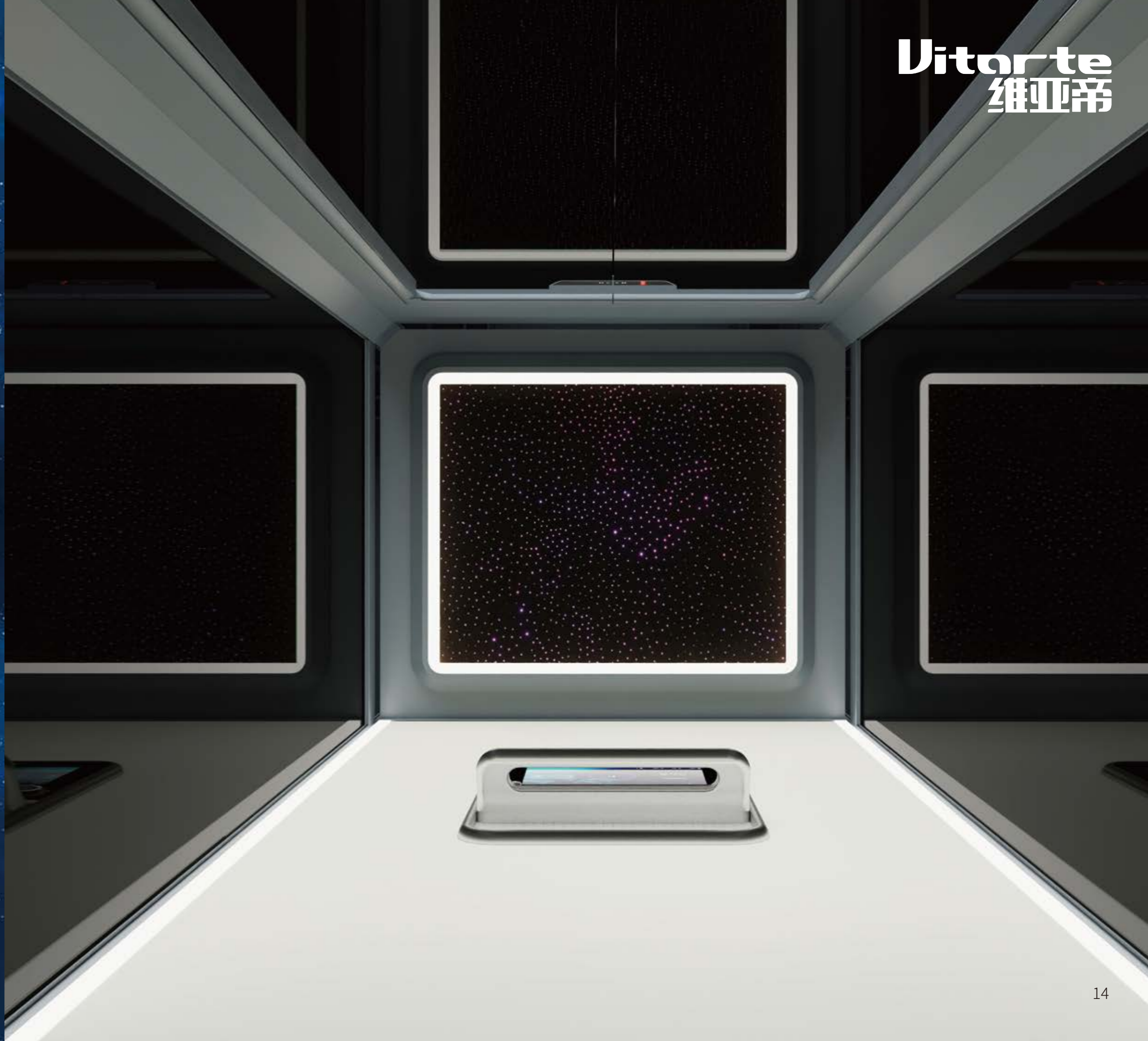

Exterior Design options

Shaft: A glass shaft creates a sense of space, with 360° light and shadow experience and riders get to enjoy beautiful views of the villa.

Colors: The use of color matches the lift with a variety of home decor styles, from simple to elegant, or flashy to quiet.

MY VILLA
MY VITARTE



ERGONOMIC HANDRAIL

- ▶ The height of the ergonomic handrail is 1.033m, which is suitable for people of different heights. The handrail arc of 135.8° is in line with ergonomic principles to ensure comfort.
- ▶ The handrail wrapped in Nappa leather, the finely textured leather surface gives a rich and luxurious.



STREAMLINE MODELING



The arc-shaped edges give off a sense of calm, while the structure and lines complement each other to prevent injuries and accidents from sharp edges. Rivets are built into the lift and integrated into the exterior, preventing corrosion and deformation of the rivets that will affect the look and safety of the lift.



Flexible space



Available in multiple sizes, Vitarte machine room-less lifts are equipped with a glass shaft without the need to prepare a pit, flexible installation with a minimum footprint of **1,014x962mm**.

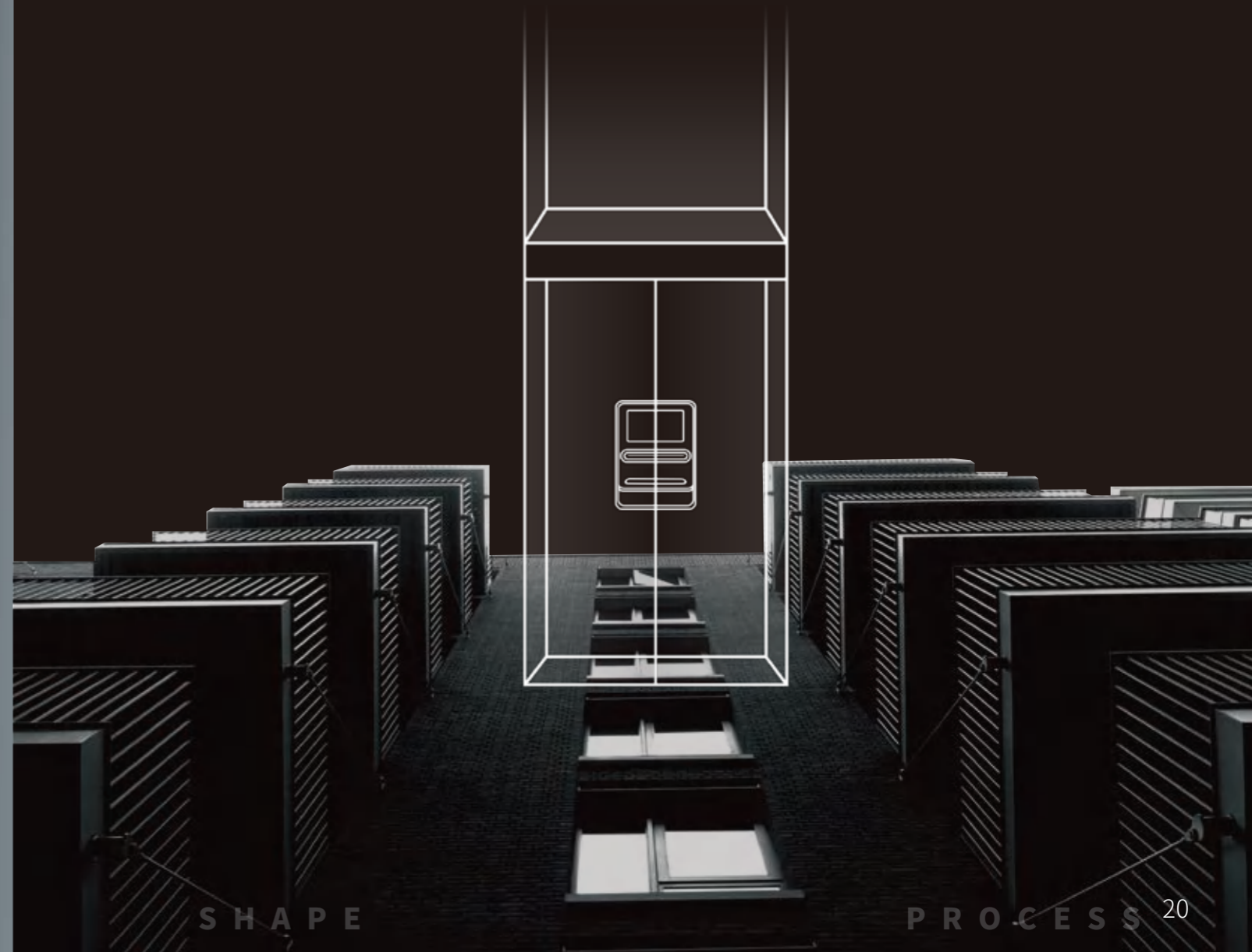



Double hinged doors

► **A/B/C three-sided door opening**

To improve accessibility, the door has a flexible opening direction on each floor depending on the house design.

► **Single and double doors**

Multiple door opening options for better space adaptability.

► **Ultra-quiet double door with smart system secure safety**

The new-generation door technology that features an ultra-quiet gate switch. Anti-pinch can also be configured to prevent injuries, making it user-friendly for families with children.



Single Swing Door



MY VILLA
MY VITARTE



Smart

CREATING A SMART FUTURE

Smart technology prioritizes safety

Tianji system

Combining the advantages of screw-driven lifts and traction lifts, the Tianji system enhances comfort and safety, as well as promote a pleasant riding experience.

Taiji system

Physical buttons and a smart touchscreen display are available for flexible lift control to promote safety and meet the daily usage habits of family members in different age groups.

Smart control

It allows settings for multiple functions such as virtual elevator buttons, news, weather, sleep time, door-open waiting time, background music, wallpapers, and more.

Customized settings

The 15.6-inch large screen offers smart services that can be configured, creating new standards for leading a smart lifestyle.



Customized settings

The 15.6-inch large screen offers smart services that can be configured, creating new standards for leading a smart lifestyle.



▶ **Large screen settings:**

Touch screen, news, weather, background theme, emergency contact

▶ **Sound settings:**

Voice announcement, background music, volume adjustment, music selection

▶ **Lift settings:**

Sleep mode

▶ **News settings**

Headlines, news, politics, finance, sports, entertainment, education, etc.

▶ **System settings:**

Lift code, system version, privacy agreement, user agreement, IP address, restart system, check for updates.

▶ **Other settings:**

Lift code, system version, privacy agreement, user agreement, IP address, restart system, check for updates.

Vitar-te

Lift fault records

The backend system is remotely interconnected to send alerts when the lift malfunctions, and faults are recorded for service staff to check and conduct maintenance in the future. The service team can also provide remote assistance to ensure lift safety in real time.



MY VILLA
MY VITARTE



.....
Safety



Round exterior and square interior, transporting people to a blissful home

A circle is a symbol of nature as well as family reunion and harmony in Chinese culture.

Exuding warm vibes, Vitarte's Chinese-styled frame with round exterior and use of leather conceal the sharp edges of conventional lifts to prevent accidents and injuries. It is a perfect combination of Chinese design aesthetics and functionality.



SAFETY BRAKING SYSTEM

► Strong guide rail

The newly developed OptiRaise guide rail redefines lift standards and overcomes deflection issues in commercial lift guide rails. The high-strength and cold-rolled guide rails ensure high performance at all times.

- Yield strength of up to 520MPa
- Patent number: ZL202020339139.X
- Trademark number: 65659800

► Independently developed shaft

Eighteen types of lift shafts are available for customization, and the frame stability of our lifts is better than other commercial villa lifts.

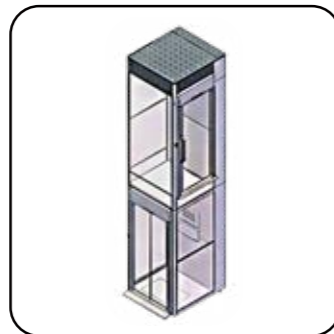
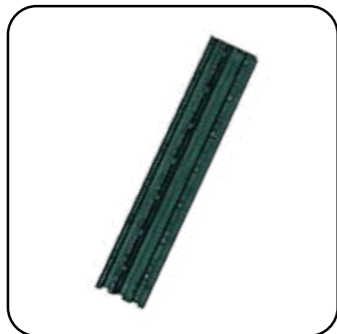



SAFE EDGES

The platform is equipped with a safety frame, which will automatically sink when there is a pressure on the frame, then the lift will stop moving to prevent potential danger.





Emergency stop button

When the lift malfunctions, the emergency stop button can be activated for emergency braking to ensure the safety of lift passengers.



Emergency phone button

Users can set 5 emergency contacts and dial these numbers one after another with a button when there is a need to call others inside the lift



SECURITY

▶ No downtime during power outages

Vitarte's Luxe lifts can still be used in the event of a power outage as they are equipped with premium quality uninterruptible power supply batteries.

▶ Eco-friendly coating

Established over 90 years ago, Tiger Coatings is a surface coating specialist. Its products comply with China's Type II environmental label standards and the EU's Restriction of Hazardous Substances Directive. All of its products are formulated without toxic substances such as lead and cadmium, while its powder coatings are eco-friendly.

▶ Bolon carpet

The intricately woven textures in Bolon carpets are visible to the naked eye and features quality materials. The carpets meet industry testing standards, with fully recyclable materials that are free from phthalates.

▶ Environmentally sustainable

95% of the parts can be recycled.



Color Selection

As users prefer their lifts to complement their home décor, our chief designer has created **13** other colors in addition to the standard white color. Families can choose the color that matches their home, making the lift an attractive addition to their house.

Customers can easily customize their lift by visiting Lon Chuang's cloud showroom.



COLOUR

STANDARD COLORS

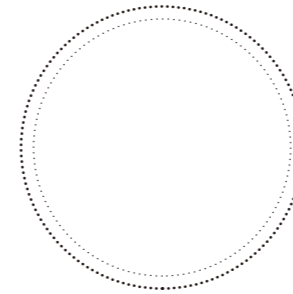

Classy white

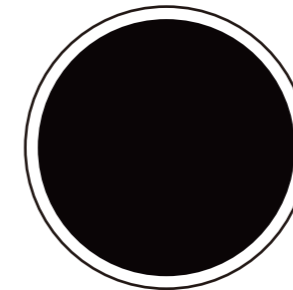

Matte black

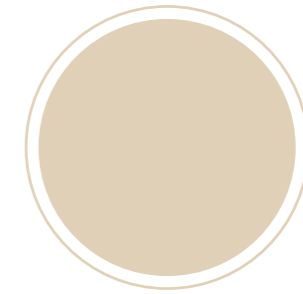

Champagne gold

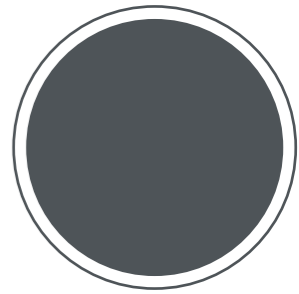

Sky gray

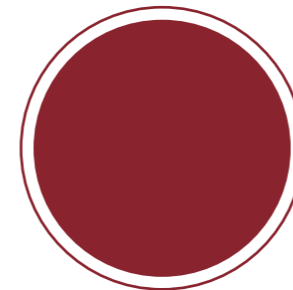

Burgundy

OPTIONAL COLORS

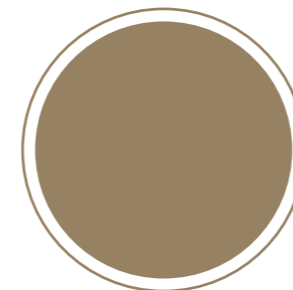

Roman bronze

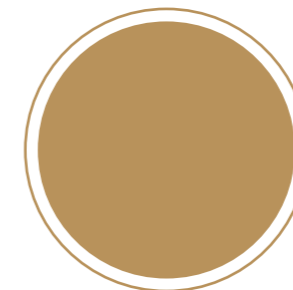

Onyx gold

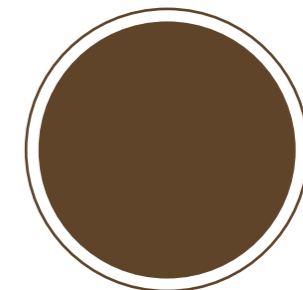

Vintage brown

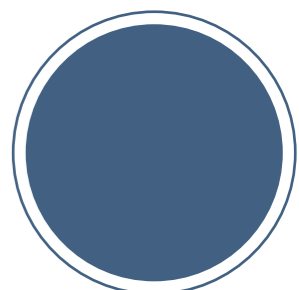

Poseidon blue

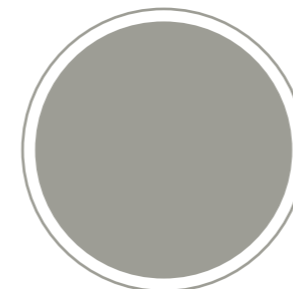

Impressionist gray

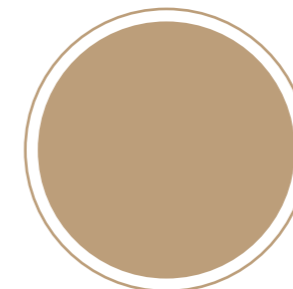

Baroque gold

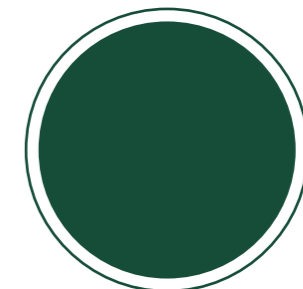

Renaissance green

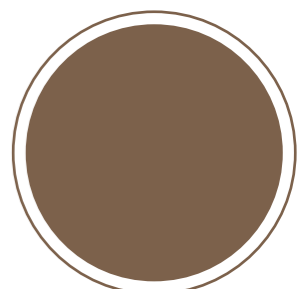

Neapolitan coffee

STARRY SKY

Starry sky ceiling



May every sunrise and sunset be accompanied by the light and shadow of the galaxy stars.
Alcantara leather, which is commonly used in luxury cars, creates a dark night sky with twinkling stars.

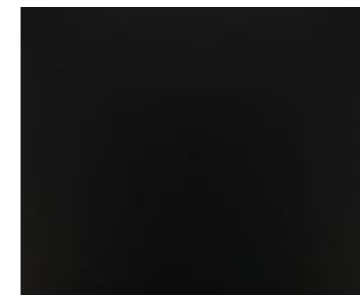

— Standard —



— Celestial Bliss —



— Shining Stars —



— Aries —

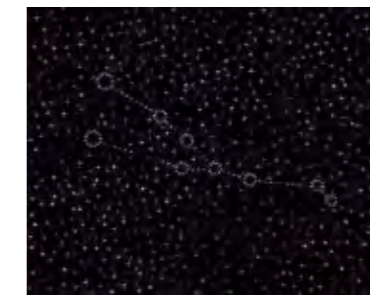

— Taurus —

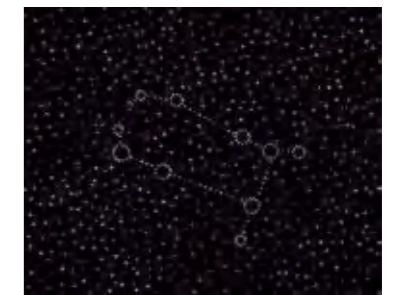

— Gemini —

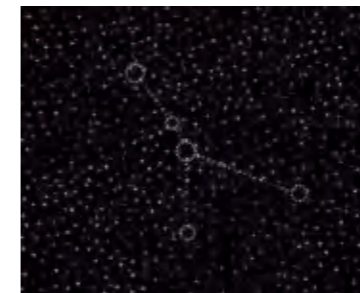

— Cancer —



— Leo —



— Virgo —



— Libra —



— Scorpio —

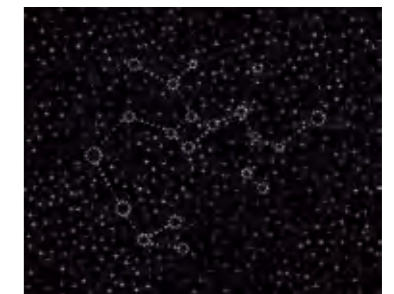

— Sagittarius —

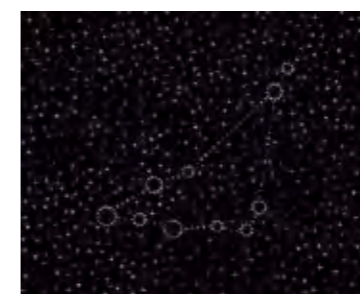

— Capricorn —



— Aquarius —



— Pisces —



Carpet choices



Bolon Graphic



Bolon Sisal Plain Sand



Bolon Flow Stream

Platform dimensions and load capacity

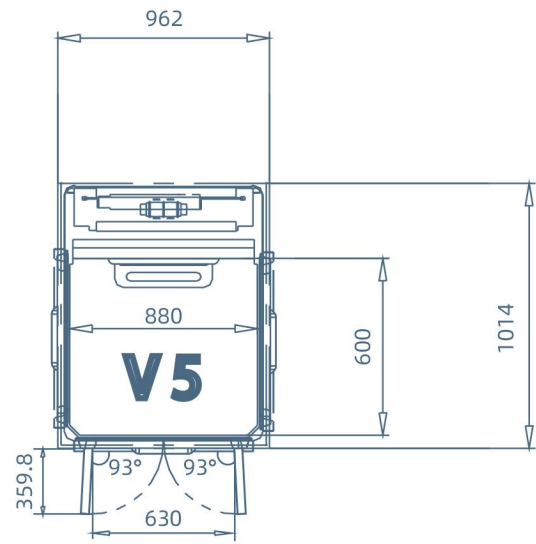

V5 1014×962mm 200kg/2 passengers

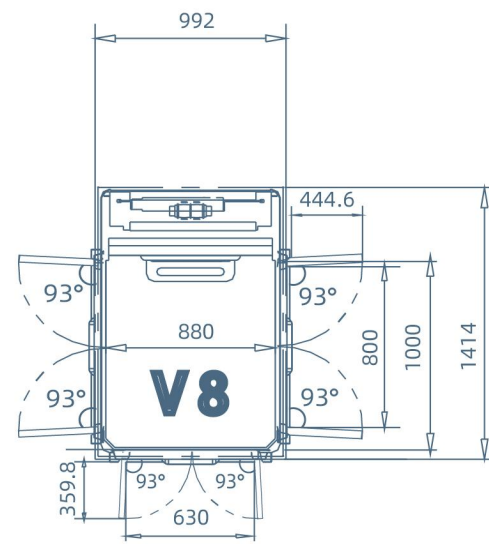

V8 1414×992mm 260kg/3 passengers

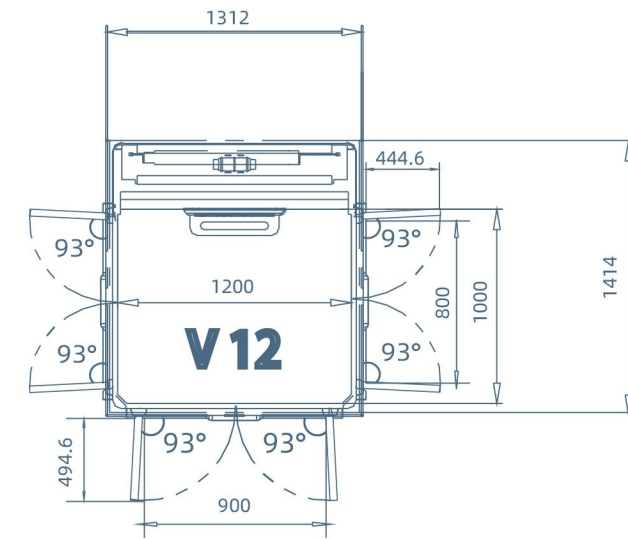

V12 1414×1312mm 400kg/5 passengers

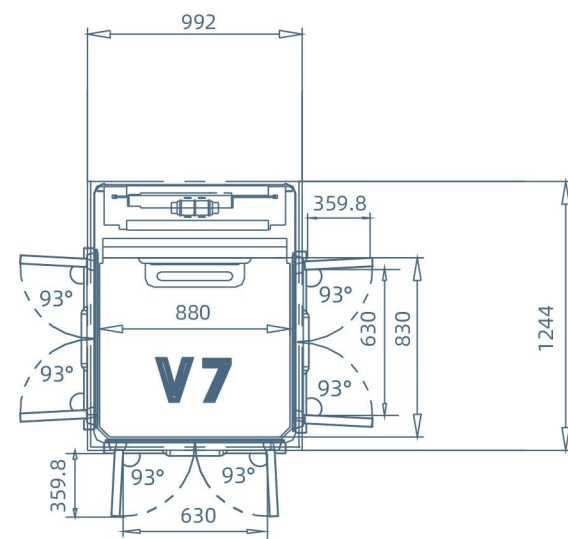

V7 1244×992mm 260kg/3 passengers

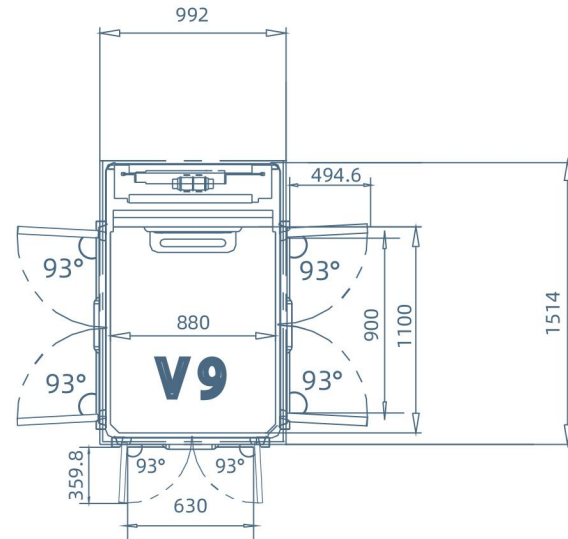

V9 1514×992mm 260kg/3 passengers

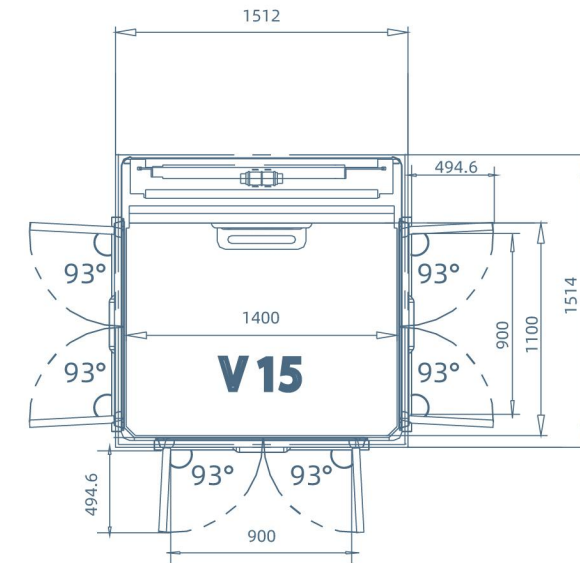

V15 1514×1512mm 400kg/5 passengers

Product Specifications

Description	Model	Platform dimensions	Reserved dimensions	Rated load	Speed	Standard: 0.3m/s
	V5	600×880mm	1014x962mm	200kg/2 passengers		
	V7	830×880mm	1244x992mm	260kg/3 passengers	Lift operations control system	Microelectronic vector control
	V8	1000×880mm	1414x992mm	260kg/3 passengers	Number of floors	2 to 6
	V9	1100×880mm	1514x992mm	260kg/3 passengers	Space requirements for pit	5cm or none below the floor surface
	V12	1000×1200mm	1414x1312mm	400kg/5 passengers	Wall background	White, beige Nappa leather
	V15	1100×1400mm	1514x1512mm	400kg/5 passengers	Platform handrail	White Nappa leather and light gray lining、 Beige Nappa leather and light brown lining
Glass	Standard: Transparent glass Optional: Grey glass、 Brown glass、 Ultra-clear glass					
Shaft material	Standard: Glass Optional: Steel plate					
Ceiling height	Minimum: 2500mm					
Drive system	Steel traction belt drive					
Braking system	Traction control system and rack and pinion brake system					
Lift door	Standard: Large glass swing door Optional: Smart double doors					
Door height	1.8m、 1.9m、 2.0m、 2.1m					
Warranty	2 years					

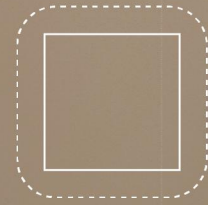

Round exterior and square interior, transporting people to a blissful home

The frame structure with Chinese design aesthetics has a round exterior and square interior, concealing the edges of conventional lifts to prevent accidents and injuries. It balances artistry and functionality, exuding restrained luxury vibes.



Space magician 2.0

Occupies a minimum area of only 0.9m², the space utilization rate can reach up to 72.30%.

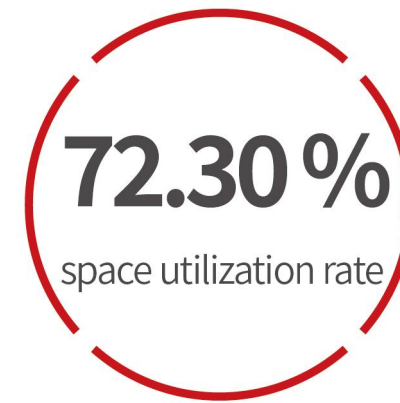

SPACE
MAGICIAN 2.0



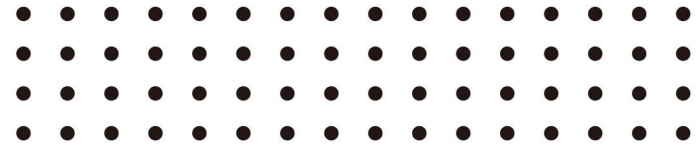

LEVATOR ANTI-BOUNCE & ANTI-MISTOUCH FUNCTION 2.0

- ▶ Accurately identify the operating status of the elevator to prevent the safety devices of the elevator from being triggered by the jumping movements of children or pets inside, which could cause the elevator to stop or trap people.



INTEGRATED DESIGN 2.0

Through rigorous industrial product design, spatial layout planning, and optimization, we have integrated the control cabinet of the Vitarte CHIC 2.0 series seamlessly into the elevator structure. It is built-in rather than externally mounted, offering a sleek appearance without occupying additional space for suspension or concealment.



ONE-CLICK RESCUE 2.0

When the elevator reports a fault code E resulting in shutdown or entrapment, simply press and hold the door open button for five seconds. The elevator will enter rescue mode, automatically level, and release the passengers.



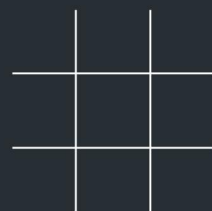

Shaft

The shaft adds a sense of space, and each floor represents a journey that allows users to enjoy the beauty of their home in different forms and from different angles.

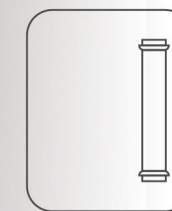

Door handle

The inner side of the single-door handle and the surface of the call button are made of Alcantara leather, which has a cozy texture.



Control panel

Black Mirror

Steering wheel - type control navigation wheel, minimalist control experience. Just twist and press to easily select floors.



Elegance of Ink

Mechanical buttons, easy to use and thoughtful, starting from your fingertips and reaching your heart.

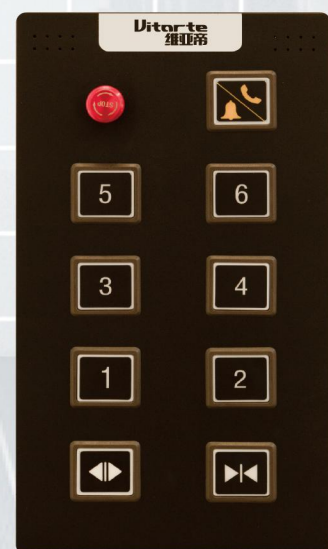

Auspicious wheels

Doors welcome blessings, bringing the household luck and wealth

The sun's rays bring warmth to the world and the encircling lines represent endless growth, symbolizing light, life and eternity.

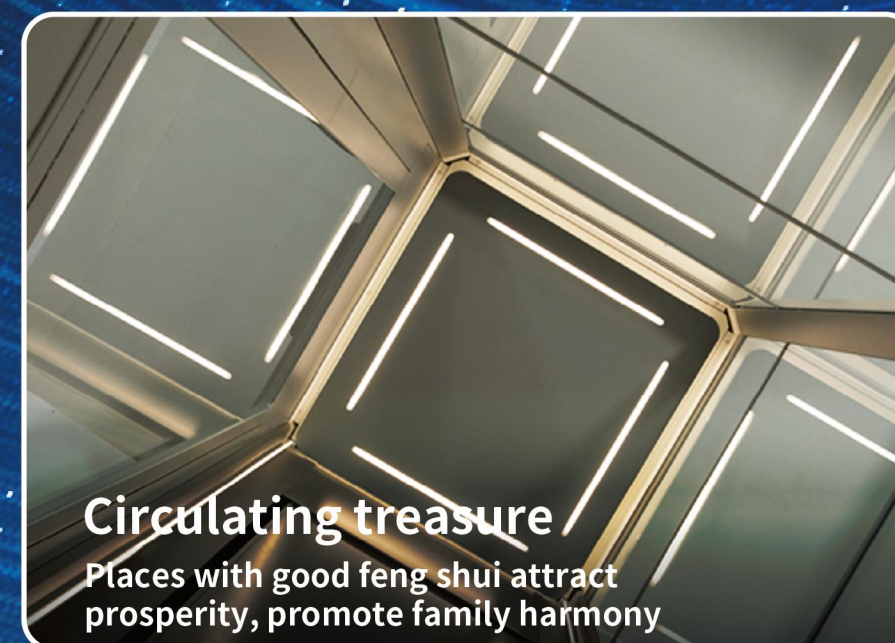

Circulating treasure

Places with good feng shui attract prosperity, promote family harmony

The round exterior and square interior resemble ancient coins used in China. Also known as "tongbao" or circulating treasure, the coins are associated with good luck, success and prosperity.

Anti-pinch door

The door will automatically hold open when there is an obstruction to prevent pinching and protect users.

Single door



Double doors

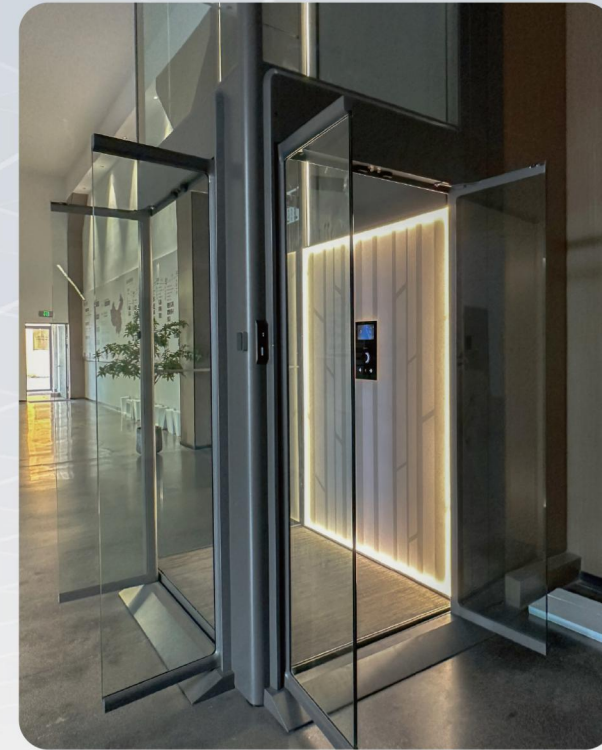

A+B side door opening

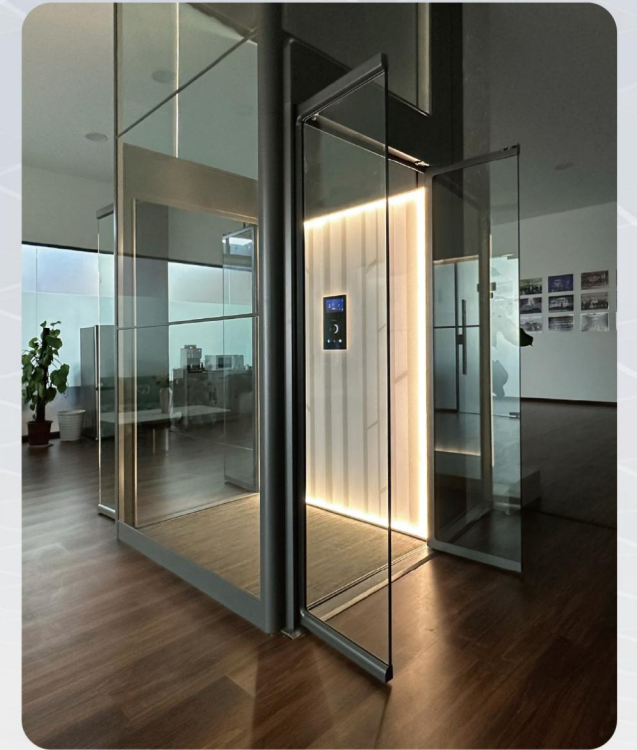

A+C side door opening

Door control technology

The doors can be opened on any two of the three sides A/B/C to link different areas of villas and mansions.

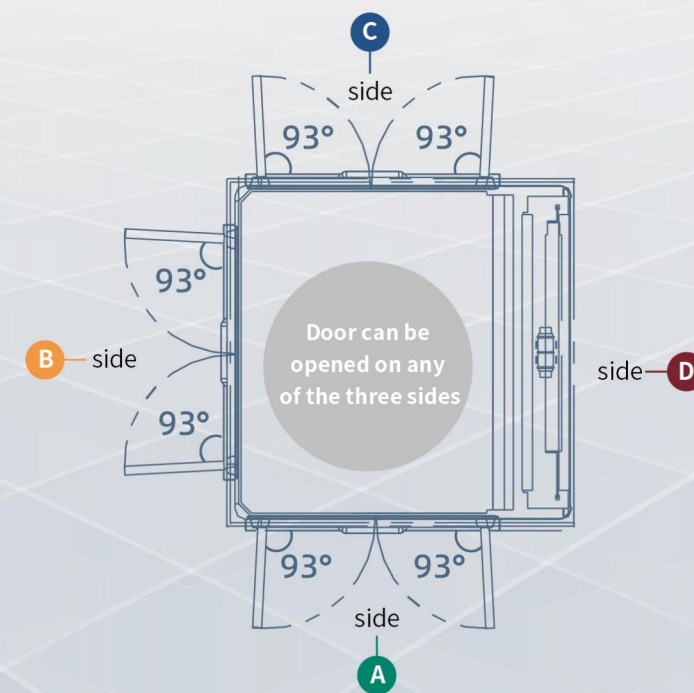



Emergency stop frame

Users need not worry about getting stuck and other safety hazards as the lift is fitted with an anti-pinch safety frame device.



Active protection to ensure safety

In the event of a power outage, the uninterruptible power supply system is activated for the lift to reach the nearest floor and release the passengers.



PRODUCT PARAMETERS 2.0

Model	Platform dimensions	The net dimensions of the elevator	Reserved dimensions (excluding door opening)	Rated load capacity
1	880*600mm	932*967mm	962*997mm	200Kg/2people
5	880*789mm	932*1156mm	962*1186mm	200kg/2people
8	880*889mm	932*1256mm	962*1286mm	260kg/3people
11	880*1000mm	932*1367mm	962*1397mm	260kg/3people
14	880*1100mm	932*1467mm	962*1497mm	260Kg/3people
50	1000*789mm	1052*1156mm	1082*1186mm	260Kg/3people
80	1100*789mm	1152*1156mm	1182*1186mm	260Kg/3people
83	1100*889mm	1152*1256mm	1182*1286mm	260Kg/3people
86	1100*1000mm	1152*1367mm	1182*1397mm	320Kg/4people
116	1200*1000mm	1252*1367mm	1282*1397mm	320Kg/4people
119	1200*1100mm	1252*1467mm	1282*1497mm	400Kg/5people
179	1400*1100mm	1452*1467mm	1482*1497mm	400Kg/5people

Note: The reserved dimensions in the table do not include the door opening dimension. The actual reserved dimension on the side where the door opens = reserved dimension + 15mm.
For more dimensions, please refer to the product dimension table.

Glass	Standard: Transparent glass
Shaft material	Standard: Glass Optional: Hoistway steel plate
Drive system	Steel traction belt drive
Platform Type	Pure platform - standard configuration; Platform with car - optional
Rated speed	0.15-0.3m/s
Lifting height	750-18,000mm
Ceiling height	≥2450
Number of floors	2 to 6
Power supply	220AC
Lift doors	Standard: Single door Optional: Double doors
Anti-trap system	Uninterruptible power supply
Emergency calls	Including
Safety features	Including
Requirements for reserved pit	50mm, with a ramp for configurations without a pit
Warranty	2 years

PATTEN WALL



Pure white wall

(Standard)



Bamboo shadows

(Standard)

Classical Chinese ink paintings of bamboo shadows are elegant, with bamboo representing beauty, a spirit of living, quality and an attitude to life.



Creative brocade

(Standard)

Inspired by the traditional Chinese brocade fabric, the vertical black background wall is complemented with rhythmic patterns to highlight the brocade's texture. The background wall emits imperial luxury vibes when it is lit up.



Geometric elegance

(Optional)

The three-dimensional combination of lines showcases charm under the reflection of light and shadow.



Precious past

(Optional)

Time flies when we are fulfilled. May our lives be filled with colors of joy.

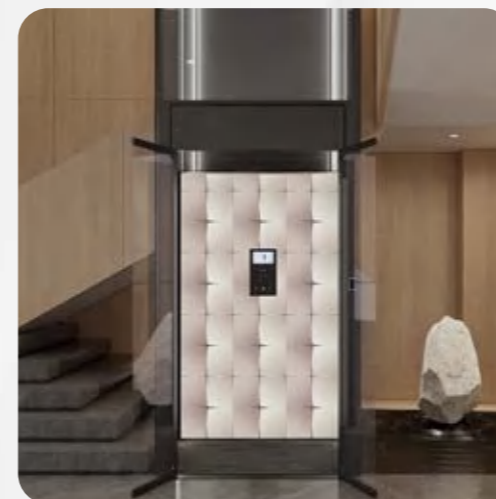

Rhythm of wind

(Optional)

The wind blows like lyrical prose or poems written on plain paper, displaying a sense of nature, serenity and sophistication



Golden jade

(Optional)

Showcases the splendor and opulence of gold, but also the brightness and energy of jade to convey dignity, elegance and dazzling beauty.

Emergency phone



(Standard)



Black/white watch style

(Optional)



Water drop

(Optional)



Wood grain

(Optional)

Color choices

There are 5 lift colors to complement the home décor and make the lift an attractive addition to the house.

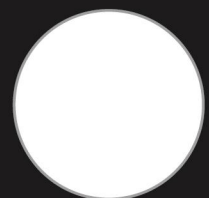

Classy White
(Standard)



Matte black
(Standard)

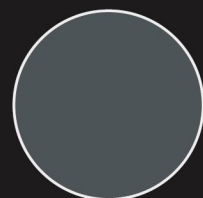

Sky gray
(Standard)

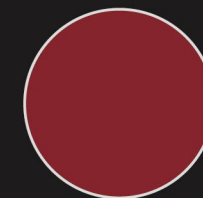

Burgundy
(Optional)

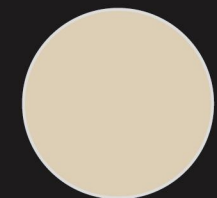

Champagne gold
(Optional)

Woven PVC carpet

Premium quality and rich color scheme
Easy to clean
Eco-friendly materials

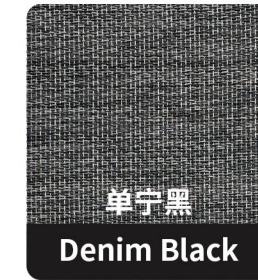

PLATFORM SIZE AND LOAD CAPACITY

Model 6

880*830mm
260kg
3 passengers

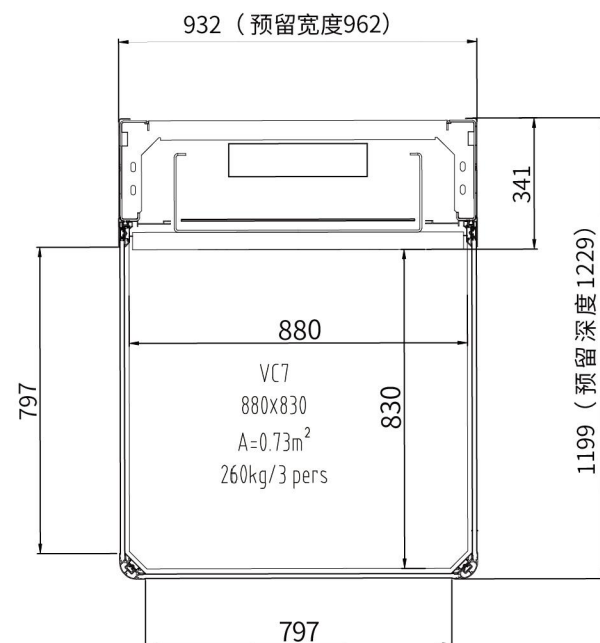

Model 89

1100*1100mm
400kg
5 passengers

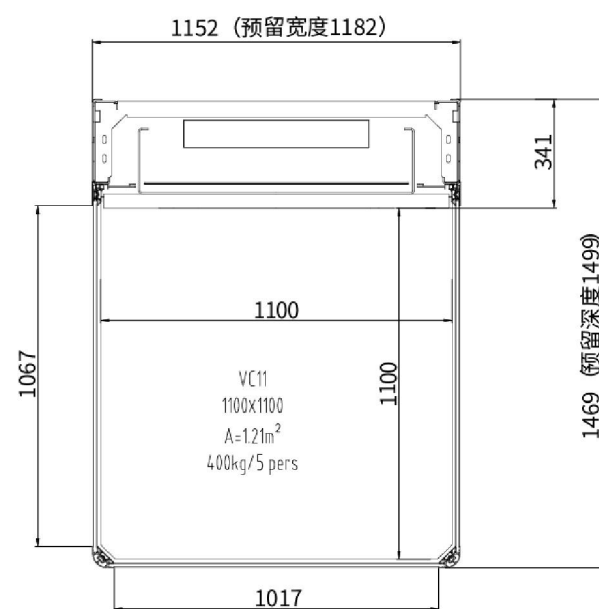

Model 14

880*1100mm
260kg
3 passengers

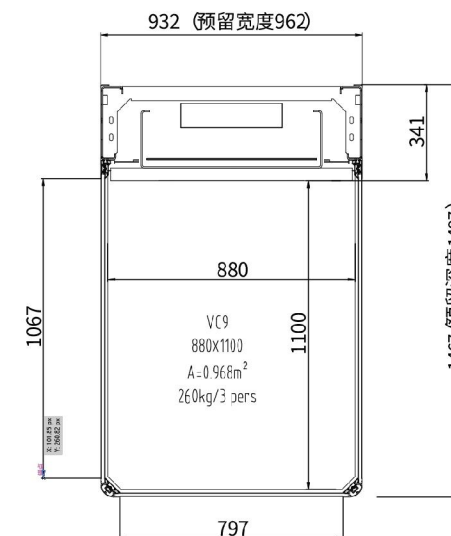

Model 116

1200*1000mm
320kg
4 passengers

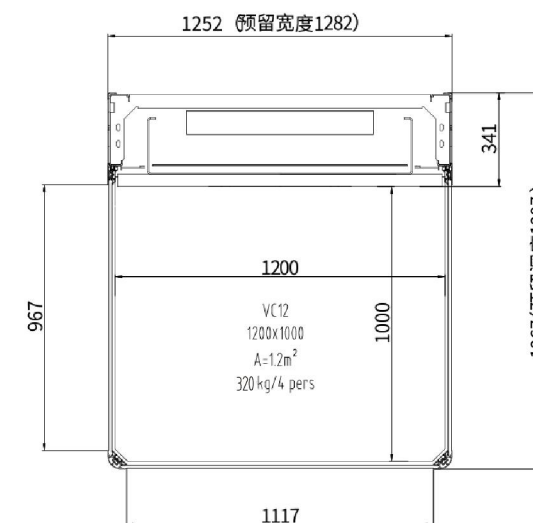

Model 179

1400*1100mm
400kg
5 passengers

